



# OPERATING INSTRUCTIONS

## MIKASA TAMPING RAMMER MT-e55



Version 1.0 (April 2024)

FOR MORE INFORMATION  
CONTACT US ON 1300 353 986 OR VISIT [flextool.com.au](https://flextool.com.au)

EXCLUSIVE TO



# Mikasa

TAMPING RAMMER

# MT-e55

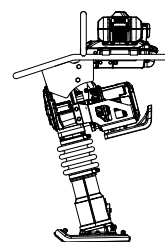

## INSTRUCTION MANUAL

en



<http://www.mikosas.com>

302-07602



## Table of contents

1. INTRODUCTION .....	1
2. FUNCTIONAL OVERVIEW.....	1
3. WARNING SIGNS .....	2
4. CAUTIONS FOR SAFETY.....	2
4.1 General Cautions	2
4.2 Cautions for Attaching and Removing the Battery Pack	3
4.3 Precautions before Starting Work	3
4.4 Precautions during Work	3
4.5 Precautions of falls	4
4.6 Precautions while Lifting	4
4.7 Precautions for Transportation and Storage	4
4.8 Precautions for Maintenance	5
4.9 Precautions for battery pack and battery charger	5
4.10 Decals Position	6
4.11 Decals List	7
4.12 Descriptions of the Warning Decals	7
5. SPECIFICATIONS.....	8
5.1 Rammer	8
5.2 DC power unit	8
5.3 Battery	9
5.4 Charger	9
5.5 Plug of Charger	9
6. APPEARANCE .....	10
6.1 Dimensions	10
6.2 Components	11
7. INSPECTION BEFORE OPERATION .....	12
7.1 Inspection	12
7.2 Battery Pack and Battery Charger	13
7.3 Attaching and Removing the Battery Pack	13
8. OPERATION .....	14
9. STOPPING THE DC POWER UNIT.....	15
10. TRANSPORTATION.....	15
11. CLEANING.....	15
12. STORAGE.....	15
13. INSPECTION AND MAINTENANCE.....	16
13.1 Maintenance Schedule	16
13.2 Inspection	16
14. TROUBLESHOOTING.....	17
14.1 DC Power Unit, Battery Pack and Battery Charger	17
14.2 Rammer	17

## 1. INTRODUCTION

- This instruction manual describes the proper methods for using the tamping rammer, as well as simple checks and maintenance. Be sure to read this instruction manual before using the rammer, in order to get full use of the excellent performance of this machine, to improve your operation and to perform work effectively.
- After reading this manual, store it in a handy location for easy reference.
- For details about the DC POWER UNIT, BATTERY PACK and BATTERY CHARGER for this machine, see the separate owner's manual for them.
- For inquiries about repair parts, parts lists, service manuals and repair of the machine, please contact the shop where you purchased it, or the Mikasa Website. In addition, parts lists are available on the MIKASA website at: <http://www.mikasas.com/english/>

The illustrations in this manual might slightly differ in part from the machine you actually purchased due to design changes.

## 2. FUNCTIONAL OVERVIEW

### Application

This rammer is small size and lightweight, but it is a powerful compacting tool capable of applying a tremendous force in consecutive impacts to a soil surface.

It will compact nearly all types of soil, except soft soil that contains too much moisture.

Use the rammer to the construction works of roads, embankments and foundation works, and backfill works of gas lines, water lines and other pipe lines.

### Warning about Incorrect Applications and Techniques

Do not use the rammer for the pile driving work, and compacting work on the rock and hard ground that is over compacted more than compaction ability of the rammer. Furthermore, in case of using the rammer on sloping ground such as the side of embankments, it may cause an accident and machine trouble like an abnormal wear due to unstable operation.

### Structure

Circular motion is converted to create impact force.

The upper section of the rammer functions as a weight and consists of the DC power unit section, gear reducer section, and reciprocating section. It also equips the handle, battery pack and control unit section to the upper section with shock absorbers.

The lower section of the rammer that compacts the ground, consists of the spring cylinder section to create sliding motion, the sloping section to tilt the machine forward, foot section to compact the ground, and bellows and protect sleeve to cover the sliding section.

### Power Transmission

This machine is equipped with the DC power unit as power unit.

Transmission of the power takes place by increasing the DC power unit speed to engage the centrifugal clutch.

The DC power unit speed is reduced to the speed required for tamping by the reduction ratio of the pinion gear and crank gear.





Circular motion is converted to create reciprocating motion through the crank gear and connecting rod.

This reciprocating motion creates jumping motion of the foot up and down through the strong coil spring of spring cylinder.

The rammer creates strong impact force to the ground by its own weight and the jumping motion of foot.

### 3. WARNING SIGNS

The triangle shaped  marks used in this manual and on the decals stuck on the main body indicate common hazards. Be sure to read and observe the cautions described.

 <b>Warning labels indicating hazards to humans and to equipment.</b>	
 <b>DANGER</b>	Denotes an extreme hazard. It calls attention to a procedure, practice, condition or the like, which, if not correctly performed or adhered to, is likely to result in serious injury or death.
 <b>WARNING</b>	Denotes a hazard. It calls attention to a procedure, practice, condition or the like, which, if not correctly performed or adhered to, could result in serious injury or death.
 <b>CAUTION</b>	Denotes a hazard. It calls attention to a procedure, practice, condition or the like, which, if not correctly performed or adhered to, could result in injury to people and may damage or destroy the product.
<b>CAUTION</b> (without at  )	Failure to follow the instructions may result in damage to property.

### 4. CAUTIONS FOR SAFETY

#### 4.1 General Cautions

##### **DANGER**

- Do not use the machine in the rain and machine wet with water.
- Do not use the machine near flames.
- Do not touch the machine with wet hands. It is dangerous about electric shock and electric leakage.

##### **WARNING**

- Do not work with this machine, when
  - you are tired or sick and not feeling well.
  - you have taken medicine or drug.
  - you have had a drink.

##### **CAUTION**

- Please read the operation manual well and work safely by using the machine properly.
- For handling of the DC power unit, battery pack and battery charger. Please read to the attached operation manuals for them.
- Please understand of the structure of this machine well.
- Make sure to do the inspection and check the machine conditions before starting operation.
- Please use protective equipment such as helmet, protective shoes, protective gloves, etc., and wear appropriate work clothes for making your work safe.
- Always wear noise protection equipment such as ear muffs or ear plugs and protective eyeglasses.
- The decals shown operation method, warning and etc. stuck on the machine are very important for your safety. Clean the machine so that the decals can be read easily. If it is difficult to read the decals, please replace with new ones.
- It is dangerous if children touch the machine. Please be careful about storage location and storage method for the machine.
- Stop the DC power unit before maintenance work.
- We are not responsible for any accidents occurred due to the fixing without using genuine parts (foot and etc.) and equipment modifications.



## 4.2 Cautions for Attaching and Removing the Battery Pack

### **⚠ DANGER**

- Be sure to press STOP on the START/STOP switch.
- Be sure to work in a clear and flat location without any combustibles nearby.
- After attaching the battery pack, make sure the battery hook and fastener are securely attached.

### **⚠ CAUTION**

- Close the battery fastener lever while removing the battery pack.

## 4.3 Precautions before Starting Work

### **⚠ CAUTION**

- Always preform a pre-operation inspection before each operation and correct any problems.
- Always check the equipment for loosened threads or bolts before starting.
- Before attaching the Battery Pack, make sure that:
  - Exterior cover is not damaged.
  - Switches are not damaged.
  - Rubber support is not damaged.
  - Battery hook is not loose or damaged.
  - Battery fastener is not damaged.
  - Battery connector is not damaged.
  - Motor wire harness is not damaged. (For GXE2.0S only)
  - There are no debris or excessive dirt on the DC Power Unit or the Battery Pack.
- During the test run
  - Check that all switches work (start and stop) properly
  - Check that all indicators light when the DC Power Unit is turned on
- Push down the rear end of the handle as shown in the left figure (A) and check that there is no damage on the shock absorbers. If it found the damaged shock absorbers, replace them with new ones by left and right set.

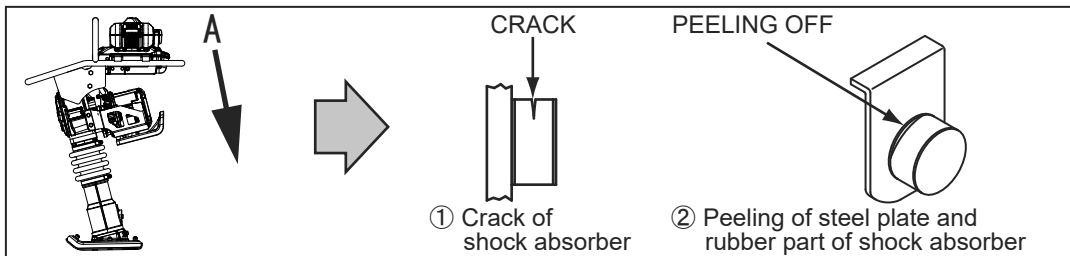

## 4.4 Precautions during Work

### **⚠ CAUTION**

- If you use the machine for a long time, be careful to watch for signs of vibration syndrome. Since this machine vibrates, work for a long time may have a negative effect on your body. Take sufficient breaks while working.
- Before starting to operate the machine, check the safety for people around and obstacles nearby.
- When starting the DC power unit, the rammer may jump suddenly. Hold the handle firmly and then pull the recoil starter.
- Always be careful around ground condition at job site. Operate the rammer in stable position and balance.
- Keep your foot away from the foot of the rammer during work. The foot of the rammer may crush your foot.
- Do not touch the DC power unit during work or soon after work, because it is very hot.
- If you find trouble or damage of the machine during work, stop work immediately.
- Before leaving or moving the machine, be sure to stop the DC power unit.
- When lifting the rammer with the handle, be careful not to pinch your fingers between the handle and main body.



## 4.5 Precautions of falls

### **DANGER**

- Take the utmost care not to fall over the rammer during work, stored or stopped. Tie down the rammer with cable (wire or rope) when stopped or stored so that it cannot fall.
- If the rammer falls over when children are nearby, they may have a serious accident.
- If the foot of the rammer is worn, the rammer will be especially unstable. If the foot of the rammer is severe worn, replace it with new one.
- If the rammer falls over during work, it will move to forward due to kicking motion of the foot while falling over. And if the ground is solid, the rammer will move quickly so it is very dangerous. After ensuring that the operator and people around are safe, press STOP on the START/STOP switch and make sure the rammer stops.
- Take careful note of safe especially when working on the public road, because a serious accident can occur easily.



## 4.6 Precautions while Lifting

### **DANGER**

- Before lifting the machine, make sure that there is no damage to parts on the machine (especially the shock absorber and the hook), loosening or missing of the bolt, and the machine must be in a safe condition.
- Stop the DC power unit before lifting the machine.
- Use adequate lifting cable (wire or rope) of sufficient strength for support to the machine.
- Do not lift it higher than necessary for safety.
- Do not use a damaged lifting cable.
- Use one point lifting hook for lifting the machine and lift straight upwards. Do not use any other points (such as the handle) for lifting.
- Never lift or suspend the machine rapidly with hydraulic excavator.
- Never allow any person or animal to stand underneath the machine while lifting.
- Be careful not to an accident when using any lifting equipment. Before using the lifting equipment, make sure that there is no trouble or damage.

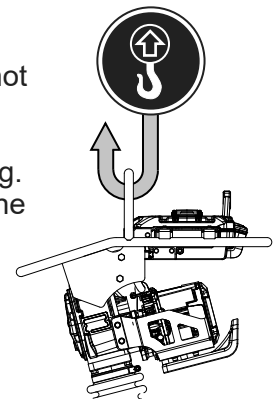

## 4.7 Precautions for Transportation and Storage

### **DANGER**

- Stop the DC power unit before transporting or storing the machine.
- After the DC power unit and main body has cooled down enough, transport or store the machine.
- Remove the battery pack before transporting or storing the machine.
- Maintain upright position of this rammer on a level ground during transporting or storing.
- Tie down the rammer with cable (wire or rope) so that it cannot move or fall over.
- When lifting the rammer with the handle, be careful not to pinch your fingers between the handle and main body.
- When transporting the rammer, use MC-1B of Mikasa Carry or similar product.
- Avoid storage areas with high temperature and high humidity, or environments with severe temperature changes. Keep away from direct sunlight and rain.



## 4.8 Precautions for Maintenance

### **WARNING**

- Ensure safety for maintenance. It needs appropriate maintenance for keeping the machine performance. Keep the machine in good condition with attention to the machine's condition always.

### **CAUTION**

- Be sure to stop the DC power unit before maintenance of the machine.
- Do not touch the parts that became hot until they have cooled down enough to prevent burn.
- Do not touch the lubrication oil and engine oil until they have cooled down enough to prevent burn.
- When maintenance of the machine with disassembling, be sure to refer the service manual and always work safely.
- After maintenance of the machine, check that the parts are assembled properly and machine conditions are safe.



## 4.9 Precautions for battery pack and battery charger

The battery pack and battery charger are provided with each owner's manual. Follow them when you operate the battery pack and battery charger.



## 4.10 Decals Position

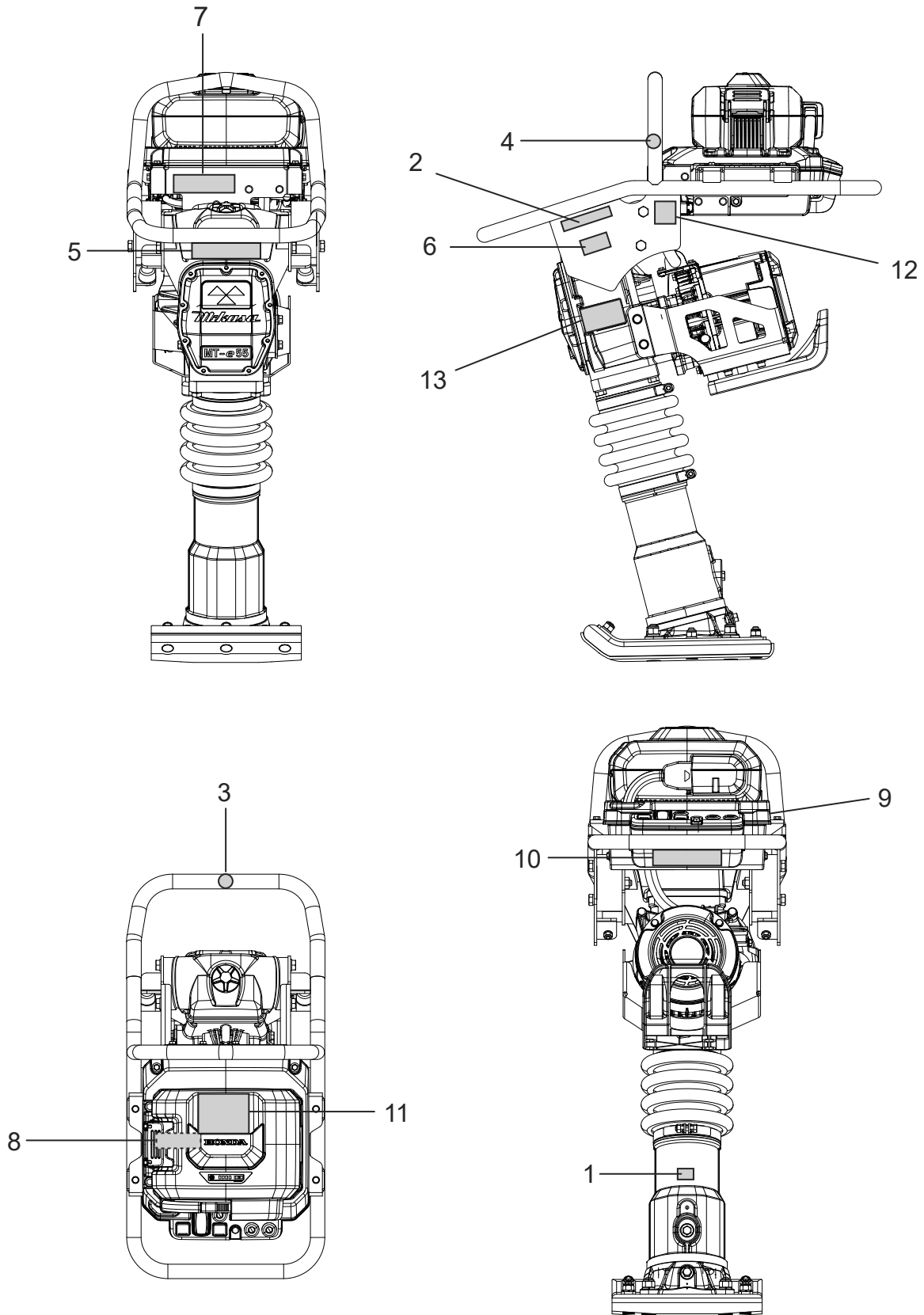

## 4.11 Decals List

No.	Part No.	Part Name	Q' TY	Label No.
1	9202-01950	DECAL,OIL SAE 10W-30	1	NPA-195
2	9202-10870	DECAL,COUTION/CONBI PL4	1	NPA-1087
3	9202-14730	DECAL,DO NOT LIFTING	1	NPA-1473
4	9202-14740	DECAL,LIFTING POSITION	1	NPA-1474
5	9202-24690	DECAL,EARTH SMART	1	NPA-2469
6	9202-24540	DECAL,COUTION/CONBI/e55	1	NPA-2454
7	9202-24550	DECAL,CAUTION HOOK	1	NPA-2455
8	9202-24560	DECAL,BUCKLE STORAGE	1	NPA-2456
9	9202-24760	DECAL,CAUTION RAINY&WASH	1	NPA-2476
10	87516-8A0-600	MARK,OPER CAUTION(EU)	1	
11	1D143-8B0-E01	LABEL,CAUTION(E)EXP/eGX	1	
12	9202-24280	DECAL,EC NOISE REQ.LWA100	1	NPA-2428
13	9202-24650	PLATE,SERIAL NO./e55/5LANG	1	NPA-2465

## 4.12 Descriptions of the Warning Decals



### Read the manual carefully.

Always read the operation manual and have good understanding of operation before working.



### Fire hazards.

Be careful of any flames during operating and storing.



### Falling hazards.

Take the utmost care not to fall over the rammer during work, stored or stopped



### Crush hazards.

During work, keep your foot away from the foot of the rammer. The foot of the rammer may crush your foot.



### Burn hazards.

Never touch the hot parts. Allow these parts to cool before servicing the machine.



### Lifting position.

Use one point lifting hook for lifting the machine.

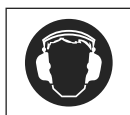

### Hearing hazards.

Always use ear plugs during operating the machine.



### No lifting position.

Do not use any other points (such as the handle) except one point lifting hook for lifting the machine.

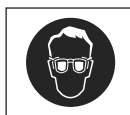

### Eye hazards

Always use eye protection during operating the machine.

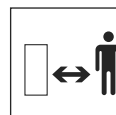

### Mechanical hazards.

During operation, be careful not to approach danger source.



### Electric shock hazards

Be careful about electric shock. Stop the DC power unit before maintenance.



Do not use the machine in the rain and wet machine.



Do not use the machine with wet hands



Do not use high pressure washer. Keep dry.

## 5. SPECIFICATIONS

### 5.1 Rammer

Model			<b>MT-e55</b>
Dimensions	Length	mm (inch)	715 (28.2)
	Width		350 (13.8)
	Height		1040 (40.9)
Plate Size	Length	mm (inch)	340 (13.4)
	Width		265 (10.4)
Lubrication Oil			API Service Categories SE or higher SAE 10W-30
Lubrication Oil Capacity		liter (qt.)	0.62 (0.66)
No. of Impacts per Second			
Rated Speed (3,600rpm)	Hz (V.P.M.)		11.5 (689)
Medium Speed (3,300rpm)			10.5 (632)
Low Speed (3,000rpm)			9.6 (574)
Impact Force			8.8 - 10.8kN (900 - 1100kgf, 1984 - 2425lbf.)
Impact Plate Stroke		mm (inch)	30 - 70 (1.18 - 2.76)
Operating Weight		kg (lbs.)	75 (165)
Retard Operating time		min/kW	About 30/1.6

### 5.2 DC power unit

Model			Honda GXE2.0S
Type			Three-phase brushless DC motor
Weight without Battery	Controller Motor	kg (lbs.)	7.1 (15.7)
			8.7 (19.2)
Cooling System			Forced Air
Max. Output			1.8kW (2.1HP, 2.2PS)/3600rpm
Voltage		V	72

※ Specifications are subject to change without notice.



### 5.3 Battery



Model			<b>Honda DP72104Z</b>
Type			Rechargeable Lithium Ion Battery
Dimensions	Length	mm (inch)	233 (9.2)
	Width		268 (10.6)
	Height		150 (5.9)
Weight	kg (lbs.)		6.4 (14.1)
Voltage Power Capacity	V		DC72V
	Wh		720
Charging temperature range	°C(°F)		5 - 30 (41 - 86) Battery Packs cannot be charged at temperatures of 5C (41F) or colder
Operating temperature range	°C(°F)		5 - 40 (41 - 104)
Storage temperature range	°C(°F)		-5 - 30 (23 - 86)

### 5.4 Charger

Model			<b>Honda CV7285Z</b>
Dimensions	Length	mm (inch)	266 (10.5)
	Width		352 (13.9)
	Height		247 (9.7)
Weight	kg (lbs.)		11.0 (24.2)
Cable Length	mm (inch)		2000 (78.7)
Input Voltage	V		AC100 - 240
Input Frequency	Hz		50/60
Output Voltage	V		DC82.8
Charging Temperature Range	°C(°F)		5 - 30 (41 - 86)
Charging Time	80%	hour	1
	100%		1.5

### 5.5 Plug of Charger

Destination		North America	Europe	Switzerland
Input Voltage	V	AC120	AC230	AC230
Plug Type				

Destination		UK	Japan
Input Voltage	V	AC240	AC100
Plug Type			

※ Specifications are subject to change without notice.

## 6. APPEARANCE

### 6.1 Dimensions

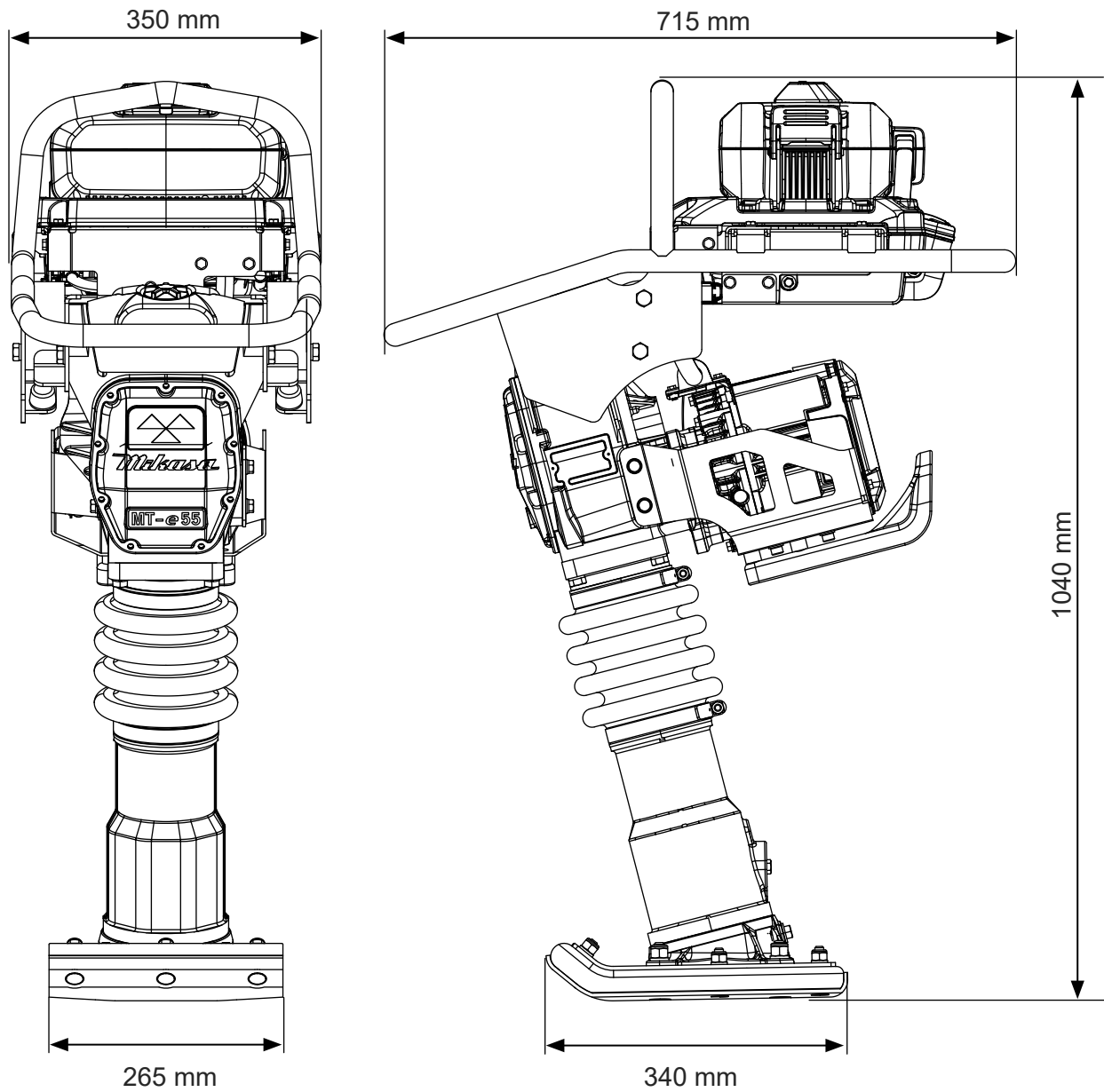

※ Specifications are subject to change without notice.

## 6.2 Components

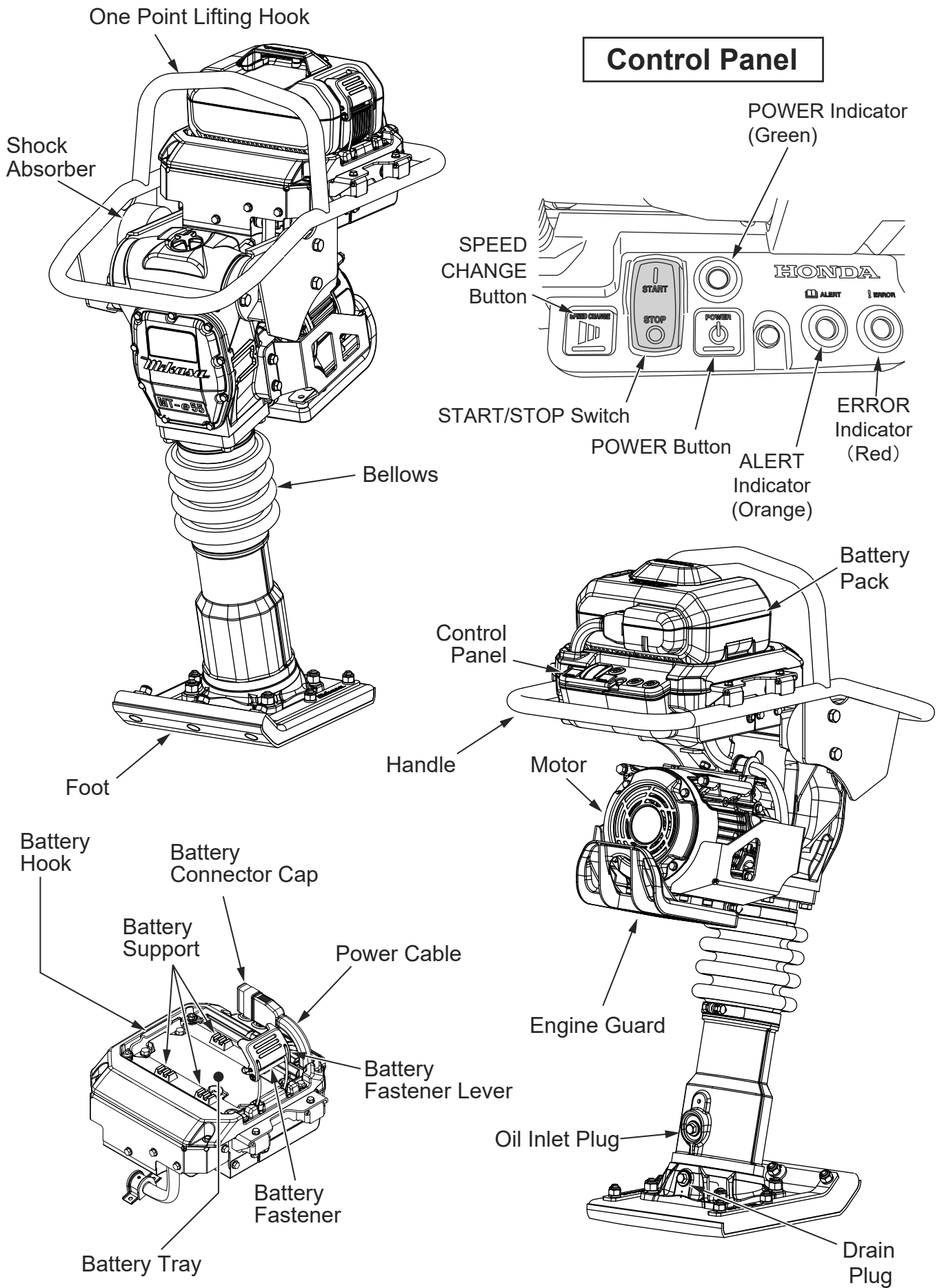

## 7. INSPECTION BEFORE OPERATION

### ⚠ WARNING

- Check the machine while the DC power unit is stopped. You may be caught in a rotating part and be seriously injured.
- Check the machine after it ties down on level ground to avoid falls.
- Check the machine after it has cooled down to avoid burns.



### ⚠ CAUTION

- It is extremely important that this section be read carefully before attempting to operate the rammer.
- Do not use your rammer until this section is thoroughly understood.
- The DC power unit, battery pack and battery charger are provided with each owner's manual. Follow them when you operate the DC power unit, battery pack and battery charger.

Inspection points	Inspection items
Appearance	Flaws, deformity, dirt
Foot	Flaws, deformity, cracks, breaks
Bolts, nuts	Loose or missing
Handle	Flaws, deformity, cracks, breaks
Shock absorber	Flaws, deformity, cracks, breaks
Main body oil	Leaks, oil level, dirt

### 7.1 Inspection

1. Clean each parts of the machine.  
Thoroughly remove dirt and oil from the machine.
2. Make sure that all bolts and nuts are not loosened. If they are loosened, retighten them to prevent an accident and trouble.
3. Make sure that the handle and shock absorbers are not damaged. If they are damaged, replace new ones.
4. Replace any missing or damaged safety and operation decals.
5. Check the main body oil from the oil inlet plug on the protection sleeve on level ground. (Fig.1) Fill to the edge of the oil inlet hole with the ecommended oil type.
  - Main body oil: API Service Categories SE or higher SAE 10W-30
  - Oil capacity: 620cc
  - Tightening torque of oil inlet plug: 39.2 N·m (400kgf·cm)
  - Tightening torque of drain plug: 49 N·m (500kgf·cm)

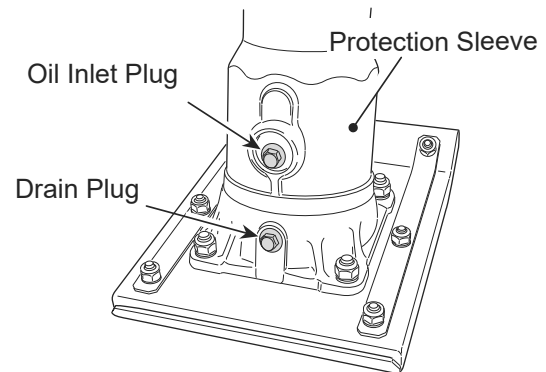

Fig.1

6. Retighten the all nuts for assembling foot (fig.2).

#### ● Tightening torque:

M10 nut: 29.4 N·m (300kgf·cm)  
M12 nut: 78.4 N·m (800kgf·cm)

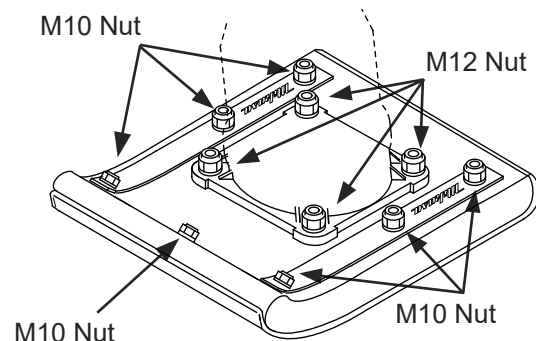

Fig.2

## 7.2 Battery Pack and Battery Charger

The battery pack and battery charger are provided with each owner's manual. Follow them when you operate the following operations of battery pack and battery charger.

- Charging and Charge Level
- Cleaning
- Storage
- Disposal

## 7.3 Attaching and Removing the Battery Pack

Follow the owner's manual for the DC power unit when attaching and removing the battery pack.

- Attaching the battery pack  
Make sure to use a genuine Battery Pack.  
1. Make sure there are no debris or dirt on the battery tray.(Fig.3)

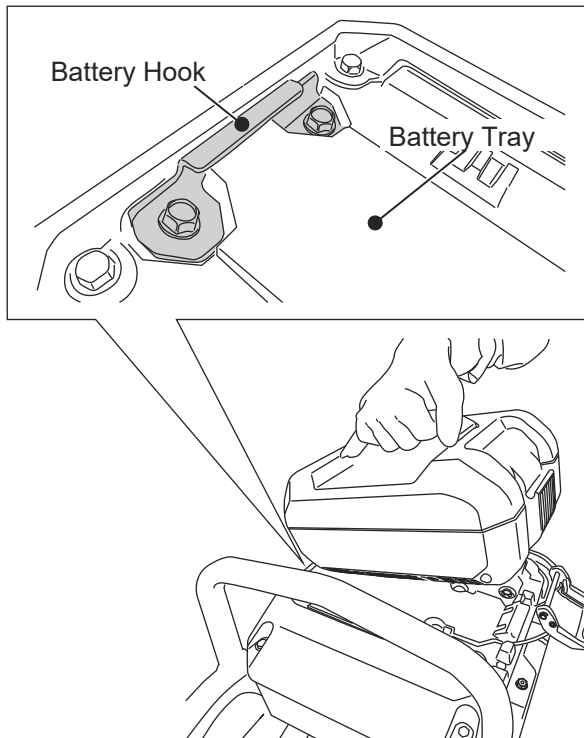

Fig.3

2. Tilt the Battery Pack and insert its claw into the battery hook.(Fig.3)
3. Push down the Battery Pack and hook the battery fastener to it.(Fig.4)
4. Push the battery fastener lever up and lock the Battery Pack.(Fig.4)  
Be careful not to catch your fingers.

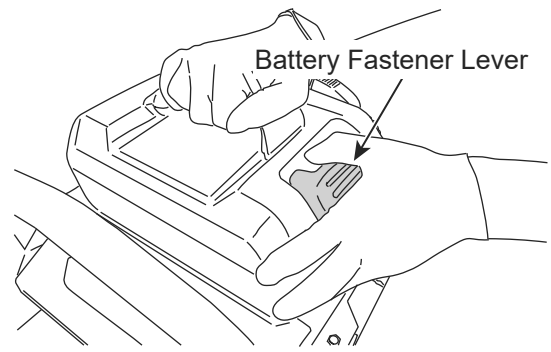

Fig.4

5. Remove the battery connector cap from the power cable.(Fig.5)  
Connect the power cable to the battery connector of the Battery Pack.(Fig.6)

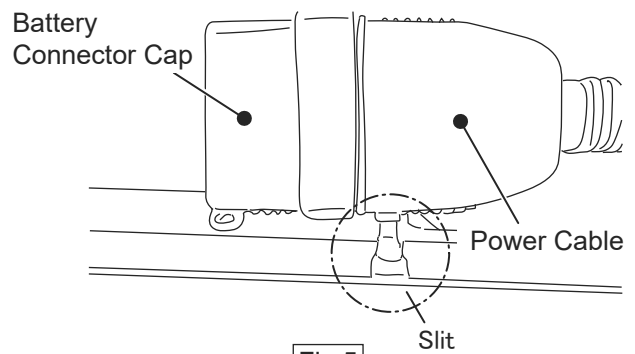

Fig.5

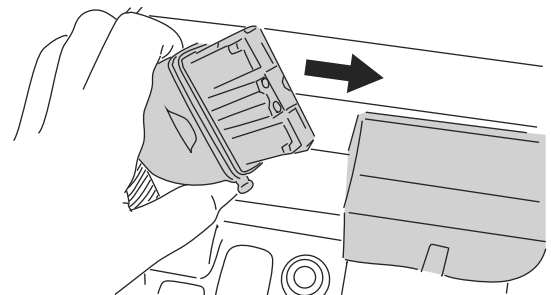

Fig.6

After attaching the Battery Pack, make sure the battery hook and fastener are securely attached.

- Removing the battery pack

1. Remove the power cable from the Battery Pack.(Fig.6)
2. Pull the battery fastener down to unlock, tilt the Battery Pack up and pull the Battery Pack claw out from the battery hook, and remove the Battery Pack.(Fig.3,4)
3. Attach the battery connector cap to the power cable.(Fig.5)



## 8. OPERATION

1. Press STOP on the START/STOP switch.
2. Press the POWER button.  
All the indicators should illuminate for a few seconds, and then only the POWER indicator remains illuminated.
3. Hold the handle firmly. Then, Press the START/STOP switch to the START position to start tamping action by starting the DC Power Unit.
4. Push the SPEED CHANGE button to set the DC Power Unit speed as required.

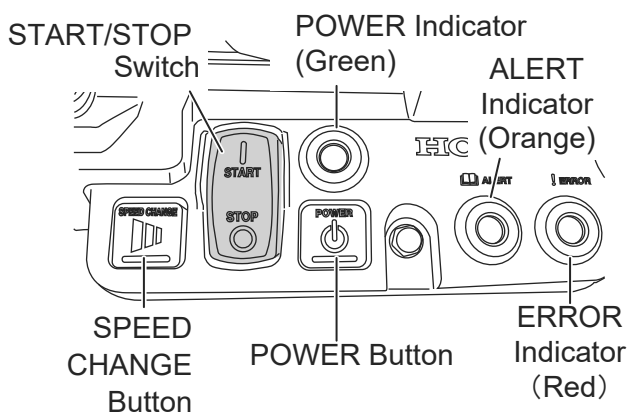

SET SPEED (Three Stages)	
Number of the SPEED CHANGE button pushes	SPEED
Starting (0 times)	Rated Speed
↓	↓
Once	Medium Speed
↓	↓
Twice	Low Speed
↓	↓
Three times	Rated Speed
↓	↓
•	•
•	•
•	•

Fig.7

### CAUTION

- If the POWER button is pressed when the START/STOP switch is in the START position, the POWER indicator remains off and the ALERT indicator flashes. In this case, the DC Power Unit cannot start. Press the START/STOP switch to the STOP position and then press the POWER button.
- It may take some time for the indicators to light after the POWER button is pressed. If the indicators do not light, press the POWER button again.
- If the DC Power Unit is not operated for about one minute after the POWER button is pressed, the POWER indicator turns off. Press the POWER button again to start the DC Power Unit.

5. MT-e55 is designed to advance while tamping. For faster advance, pull back slightly on the handle so that rear of foot contacts soil first.

### CAUTION

- DO NOT use this machine on ground that is harder than the machine can handle, or for driving pilings or tamping rock beds. Furthermore, use of the machine on sloping ground, such as the side of an embankment, may make the machine unstable and can cause an accident. It can also result in premature machine wear due to uneven loads on the machine.
- Use the machine with confidence for tamping earth and sand, soil, gravel, and asphalt.
- DO NOT use the machine for other types of jobs.
- In cold weather, the rammer can be warmed up by Pressing the START/STOP switch START and STOP several times until the rammer operates smoothly.

## 9. STOPPING THE DC POWER UNIT

Press the START/STOP switch to the STOP position.  
The DC Power Unit stops and the POWER indicator turns off.

### CAUTION

You can also stop the DC Power unit by pressing the POWER button, but it may take some time to stop.

## 10. TRANSPORTATION

1. Stop the DC Power unit before transporting the machine.
2. Do not move the machine until the DC Power Unit and main body have cooled down enough.
3. Remove the Battery Pack.
4. Maintain upright position of the rammer on a level ground during transporting.
5. Tie down the rammer with cable (wire or rope) so that it cannot move or fall over during transporting.

## 11. CLEANING

Do not use a hose or pressure washer to spray water on the DC Power Unit and Battery Pack while cleaning them. Water entering the components may cause a malfunction.

## 12. STORAGE

1. Store the machine the same procedure as 10. TRANSPORTATION.
2. Avoid storage areas with high temperature and high humidity, or environments with severe temperature changes. Keep away from direct sunlight and rain.
3. Put a cover on the machine to avoid depositing dirt.

## 13. INSPECTION AND MAINTENANCE

Proper maintenance is essential for safe, economical, reliable, and environmentally friendly operation.

### ⚠ WARNING

- Check the machine while the DC power unit is stopped. You may be caught in a rotating part and be seriously injured.
- Check the machine after it ties down on level ground to avoid falls.
- Check the machine after it has cooled down to avoid burns.



Regarding the inspection and maintenance of the DC Power unit, Battery Pack and Battery Charger, always follow each owner's manuals.

### 13.1 Maintenance Schedule

How often?	Place to check	Item to check	Reference
Daily (before starting operation)	Appearance	Flaws, deformity, dirt	
	Bolts, nuts	Loose or missing parts	
	Handle	Flaws, deformity, cracks, breaks	
	Shock absorber	Flaws, deformity, cracks, breaks	
	Main body oil	Leaks, oil level, dirt	Engine oil
	Battery fastner lever	Flaws, deformity, cracks, breaks	
Every 200 hours	Main body oil	Replace, after the first 50 hours	Engine oil

### ⚠ CAUTION

- The above table shows the check frequency for standard condition.
- The check frequency may vary depending on the condition in which the machine is used.

### 13.2 Inspection

#### 1. Daily inspection

- Clean each parts of the machine. Thoroughly remove dirt and oil from the machine.
- Make sure that all bolts and nuts are not loosened. If they are loosened, retighten them to avoid an accident and trouble.
- Retighten the all nuts for assembling foot (fig.8).
- Tightening torque:

M10 nut: 29.4 N·m (300kgf·cm)

M12 nut: 78.4 N·m (800kgf·cm)

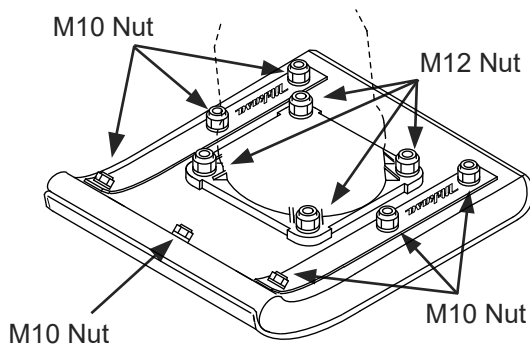

Fig.8

#### 2. 200 hours service

- Remove the oil drain plug on foot housing and drain the main body oil.
- Refill the main body oil from the oil inlet plug on the protection sleeve on level ground. Fill to the edge of the oil inlet hole with the recommended oil type.
- Main body oil: API Service Categories SE or higher SAE 10W-30
- Oil capacity: 620cc
- Tightening torque of oil inlet plug: 39.2 N·m (400kgf·cm)
- Tightening torque of drain plug: 49 N·m (500kgf·cm)

## 14. TROUBLESHOOTING

### 14.1 DC Power Unit, Battery Pack and Battery Charger

Regarding the troubleshooting of the DC Power Unit, Battery Pack and Battery Charger, please refer to each owner's manual.

### 14.2 Rammer

- DC Power Unit starts normally, but tamping stroke is not stable or it does not tamping.

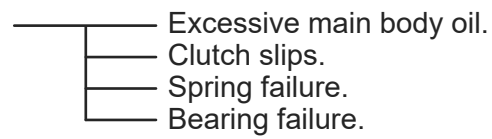

*Mikasa*

MIKASA SANGYO CO., LTD.

1-4-3, Kanda-Sarugakucho, Chiyoda-ku, Tokyo, 101-0064, Japan

PRINTED IN JAPAN



## **Parchem Construction Supplies Pty Ltd**

1956 Dandenong Road, Clayton VIC 3168, Australia

Phone: 1300 353 986

[flextool.com.au](http://flextool.com.au)

ABN 80 069 961 968

This manual summarises our best knowledge of the product based on the information available at the time of publication. You should read this manual carefully and consider the information in the context of how the product will be used. Our responsibility for products sold is subject to our standard terms and conditions of sale.

### **DISCLAIMER:**

Any advice, recommendation, information, assistance or service provided by us in this manual is given in good faith and is believed by us to be appropriate and reliable. However, any advice, recommendation, information, assistance or service provided by us is provided without liability or responsibility PROVIDED THAT the foregoing shall not exclude, limit, restrict or modify the right entitlements and remedies conferred upon any person or the liabilities imposed upon us by any condition or warranty implied by Commonwealth, State or Territory Act or ordinance void or prohibiting such exclusion limitation or modification. The product can be expected to perform as indicated in this manual so long as operation and operational procedures of the individual products are followed as recommended in this manual.

Design and technical specifications may be subject to changes.

© This publication is copyright. All rights are reserved. Flextool is a registered trade mark of Parchem Construction Supplies Pty Ltd. Mikasa is a registered trade mark of Mikasa Sangyo Co. Ltd, used under licence.

**FOR MORE INFORMATION**  
CONTACT US ON **1300 353 986** OR VISIT [flextool.com.au](http://flextool.com.au)

**EXCLUSIVE TO**

